

SPECIFICATION

MODEL	BM-360SH15	
POWER SUPPLY	DC 24V	
RATED LOAD	150 kg	
ROPE SPEED	14 m/min	
LENGTH OF WINDING	Ø5.56×12m (aircraft cable)	
MOTOR	OUTPUT	CURRENT
	440W	23A
WINCH RATING	10min	
WEIGHT	12 kg	

Accessories 1.Wire Rope Ø5.56×8m  
with Swivel Hook(0.5t)  
2.Handle  
Safty Device Slip Clutch

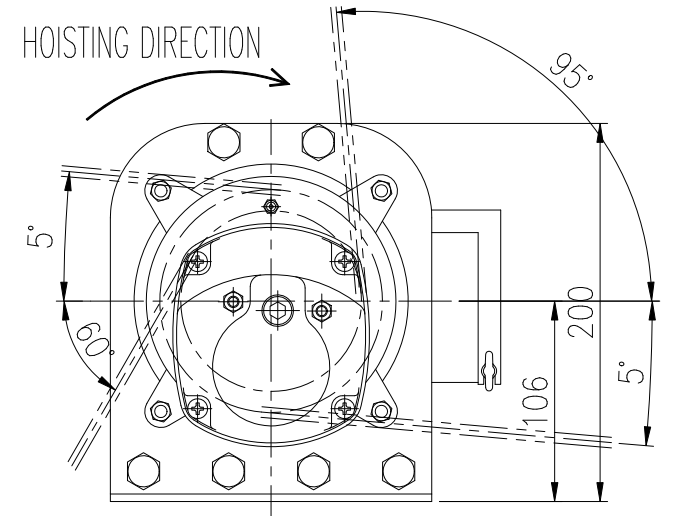

TYPE	BM-360SH15
NAME	OUTLINE
DRAWN No.	029467